

Show #1

⑤ Jog over poles

NSNS - classes 1-8, 14-15

- | | |
|-----------------|-------------|
| 1. All Breed L1 | 7. Rookie A |
| 2. L1 Horse | 8. Y 13↓ |
| 3. L1 Y 13↓ | 14. AB 14↓ |
| 4. L1 Y 14-18 | 15. AB 15↑ |
| 5. L1 AM | |
| 6. Rookie Y | |

④ Lope Right lead

⑥ Lope Left lead over poles

③ Jog over poles

⑦ Jog into box, halt
- 360° either way
- walk out

② walk into chute
- Back
- Sidepass left
- walk over poles

① Start at gate
- Right hand push gate.

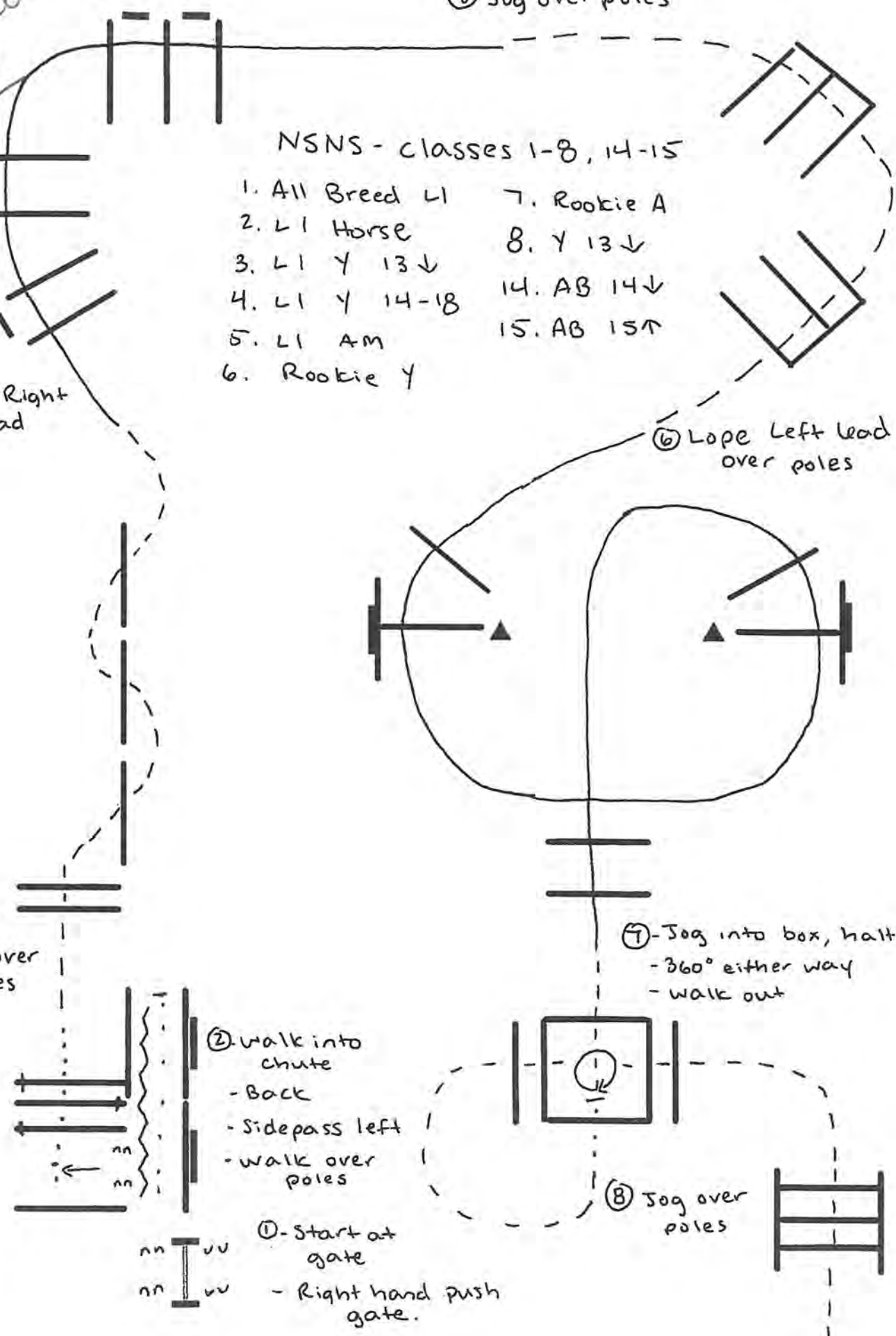

SHOW #1

NSNS - classes 9-13

- 9. Y 14-18
- 10. Jr Horse
- 11. Sel. Am.
- 12. Amateur
- 13. Sr Horse

④ Right lead over poles

⑤ change lead (flying or simple)
- lope left lead over poles.

⑥ Jog over poles into box
- 360° either direction

③ Jog over poles.

② - walk into chute
- Back
- sidepass left
- walk over poles

① - start at gate
- Right hand push gate.

⑦ Jog out of box over poles to exit

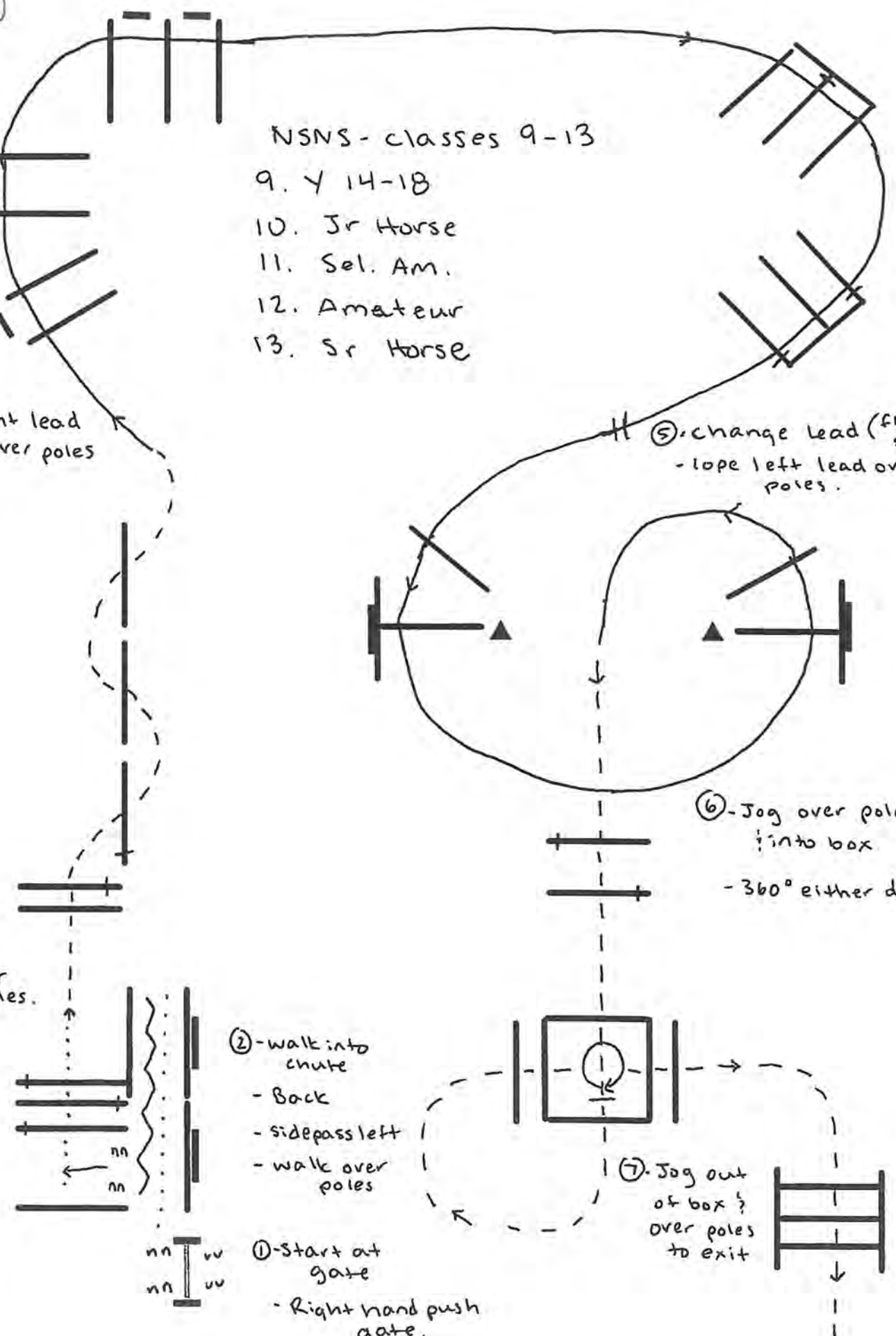

SHOW #

⑤ walk over poles

NSNS - classes 16-20

- 16. LI Y. w/T
- 17. LI Am. w/T
- 18. AB w/T 11↓
- 19. AB w/T 14↓
- 20. AB w/T 15↑

④ jog over poles

⑥ jog over poles
? into box

③ Jog over poles

⑦ -270° turn to the Right
- walk out over pole

② - walk into chute
- Back
- side pass left
- walk over poles

⑧ jog over poles to exit.

① - start at gate
- right hand push gate

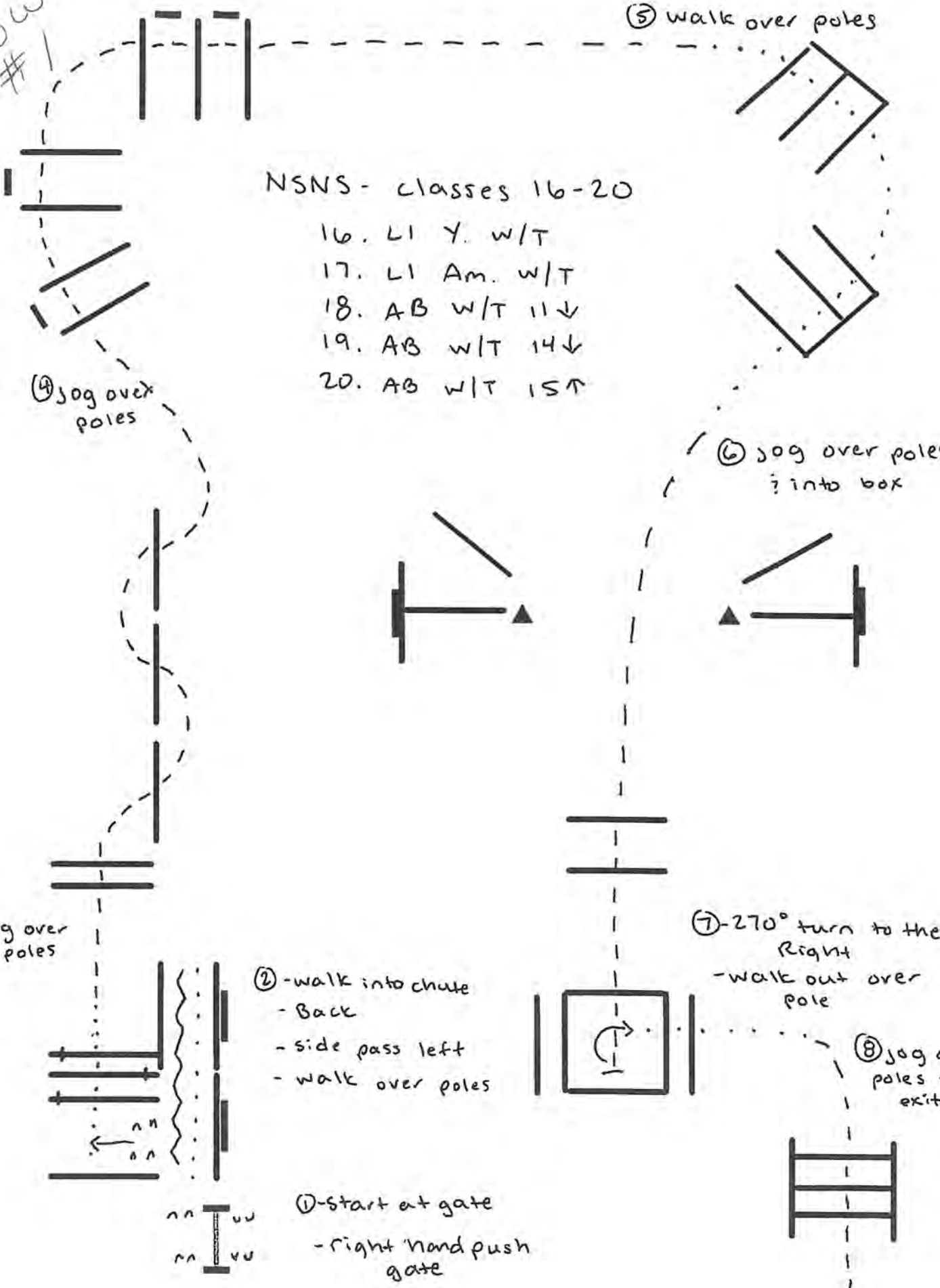

Show #2

NSNS- classes 1-8, 14-15

- | | |
|-----------------|---------------|
| 1. All Breed L1 | 7. Rookie Am. |
| 2. L1 Horse | 8. Y 13↓ |
| 3. L1 Y 13↓ | 14. AB 14↓ |
| 4. L1 Y 14-18 | 15. AB 15↑ |
| 5. L1 Am | |
| 6. Rookie Y | |

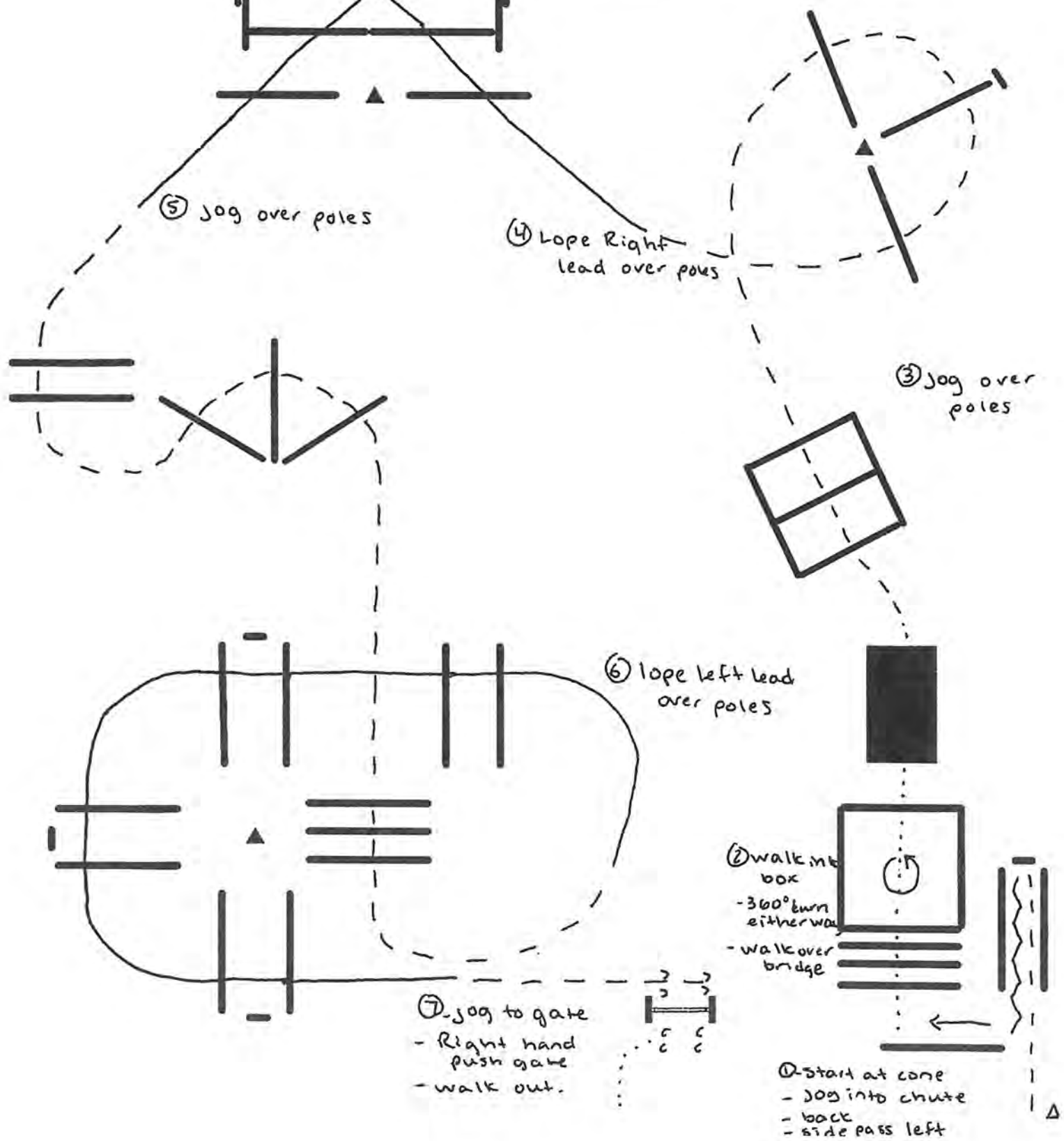
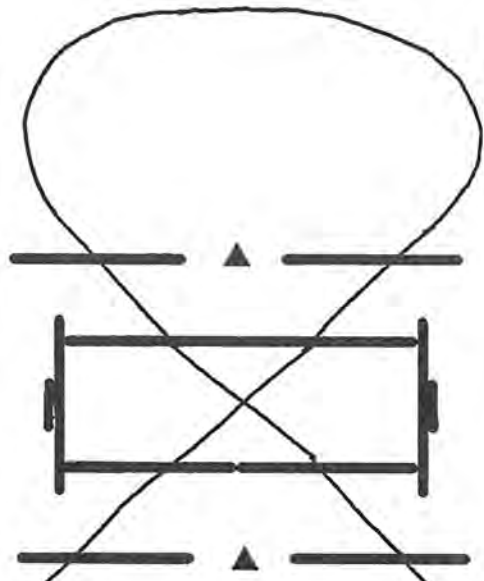

⑤ Jog over poles

④ Lope Right lead over poles

③ Jog over poles

⑥ lope left lead over poles

⑦ Jog to gate
 - Right hand push gate
 - walk out.

② walk into box
 - 360° turn either way
 - walk over bridge

① Start at cone
 - Jog into chute
 - back
 - side pass left

NSNS - classes 9-13

- 9. Y 14-18
- 10. Jr Horse
- 11. Sel. Am.
- 12. Amateur
- 13. Sr. Horse

Show #2

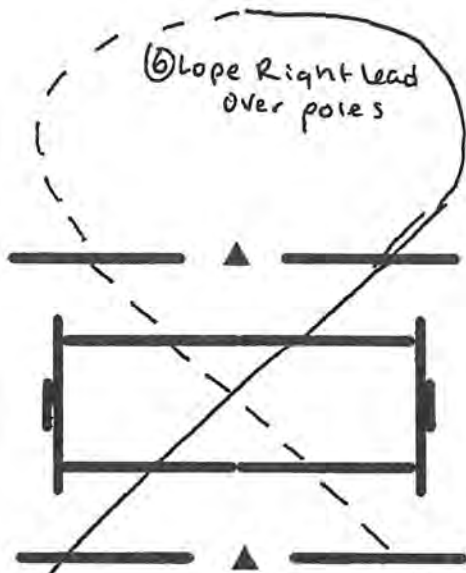

⑥ Lope Right lead over poles



⑤ Jog over poles

⑦ Jog over poles

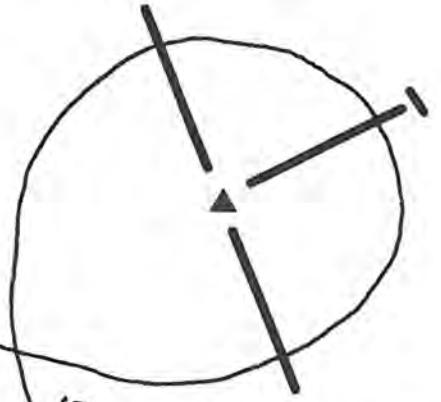

④ Lope Right lead over poles

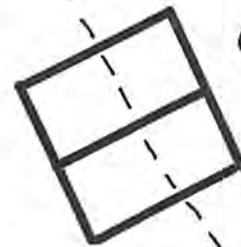

③ Jog over poles

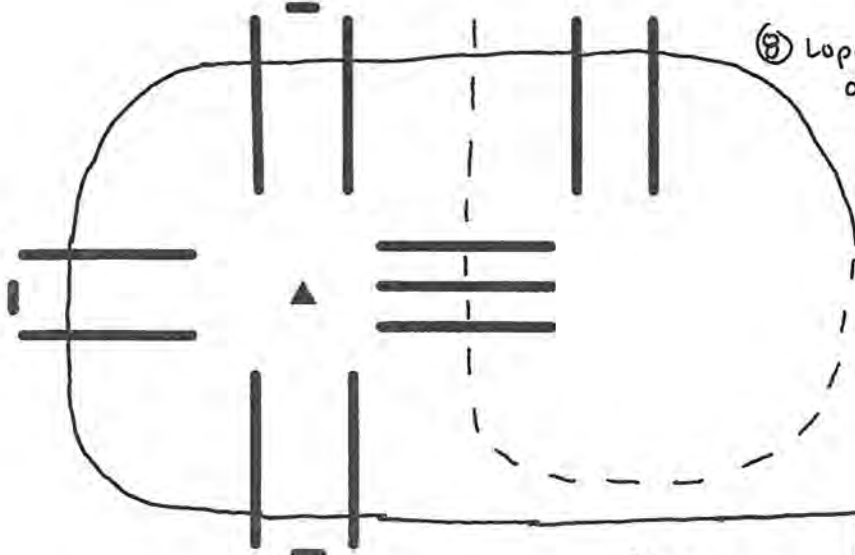

⑧ Lope left lead over poles to gate.

② Walk into box
- 360° turn either way
- walk out & over bridge

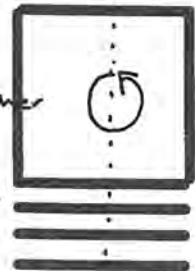

① Start at cone
- jog into chute
- back
- side pass left

④ Right hand -
push gate:
- walk out:

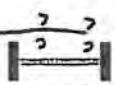

NSNS - classes 16-20

16. LI Y W/T

17. LI Am W/T

18. AB W/T 11 ↓

19. AB W/T 14 ↓

20. AB W/T 15 ↑

SHOW #2

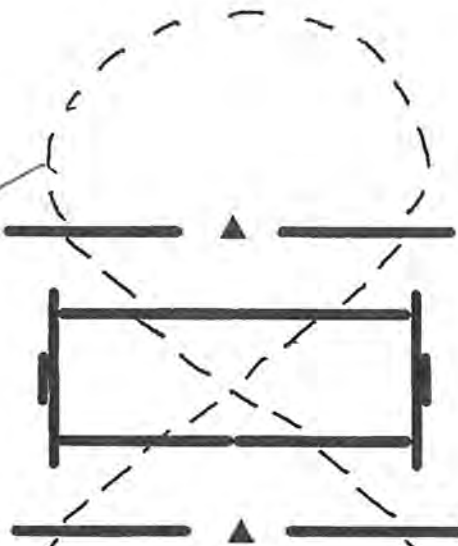

④ jog over poles

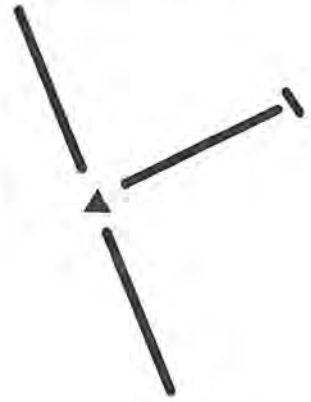

⑤ jog over poles

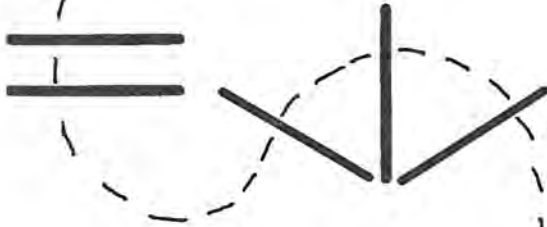

③ jog over poles

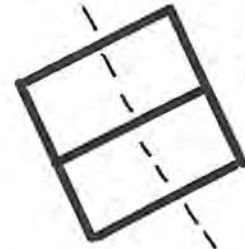

⑦ jog over poles

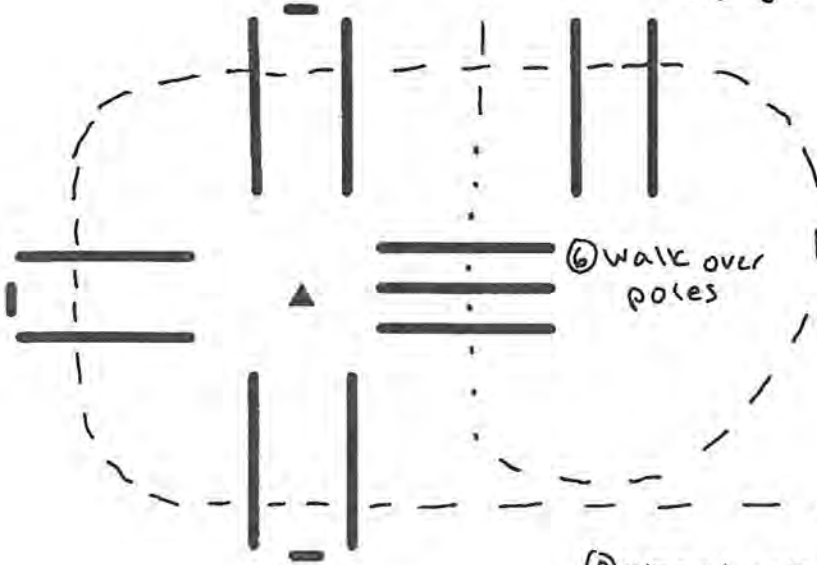

⑥ walk over poles

② walk over poles ? into box

- 360° turn either way

- walk over bridge



⑧ stop at gate

- right hand push
- walk out

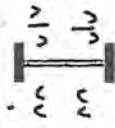

① start at cone

- walk into chute

- back

- side pass left

