

# 2020 SEPTEMBER Trophy Circuit Class Schedule

## Thur/Sun 8:00AM

### Halter

- 1 Yearling Stallions, Open
- 2 Two Year Old Stallions, Open
- 3 Three Year Old Stallions, Open
- 4 Aged Stallions, Open
- 5 Performance Stallion Halter, Open
- Grand & Res Champion Stallions
- 8 Yearling Stallions, Amateur
- 9 Two Year Old Stallions, Amateur
- 10 Three Year Old Stallions, Amateur
- 11 Aged Stallions, Amateur
- 12 Performance Stallions, Amateur
- Grand & Reserve Stallions, Amateur
- 15 Yearling Geldings, Open
- 16 Two Year Old Geldings, Open
- 17 Three Year Old Geldings, Open
- 18 Aged Geldings, Open
- 19 Performance Gelding Halter, Open
- Grand & Res Champion Geldings
- 22 Yearling Geldings, Amateur
- 23 Two Year Old Geldings, Amateur
- 24 Three Year Old Geldings, Amateur
- 25 Aged Geldings, Amateur
- 26 Performance Gelding Halter, Amateur
- Grand & Reserve Amateur, Geldings
- 29 Yearling Geldings, Level 1 Amateur
- 30 Two Year Old Geldings, Level 1 Amateur
- 31 Three Year Old Geldings, Lev 1 Amateur
- 32 Aged Geldings, Level 1 Amateur
- 33 Performance Geldings, Level 1 Amateur
- 34 Yearling Fillies, Open
- 35 Two Year Old Mares, Open
- 36 Three Year Old Mares, Open
- 37 Aged Mares Open
- 38 Performance Mare Halter, Open
- Grand & Reserve Champion Mares
- 41 Yearling Mares, Amateur
- 42 Two Year Old Mares, Amateur
- 43 Three Year Old Mares, Amateur
- 44 Aged Mares, Amateur
- 45 Performance Halter Mare, Amateur
- Grand & Reserve Amateur Mares
- 48 Yearling Mares, Level 1 Amateur
- 49 Two Year Old Mares, Level 1 Amateur
- 50 Three Year Old Mares, Level 1 Amateur
- 51 Aged Mares, Level 1 Amateur
- 52 Performance Mares Level 1 Amateur
- 53 Yearling Geldings, Youth
- 54 Two Year Old Geldings, Youth
- 55 Three Year Old Geldings, Youth
- 56 Aged Geldings, Youth
- 57 Youth Performance Halter Gelding
- Grand & Reserve Youth Geldings
- 60 Yearling Geldings, Level 1 Youth
- 61 Two Year Old Geldings, Level 1 Youth
- 62 Three Year Old Geldings, Level 1 Youth
- 63 Aged Geldings, Level 1 Youth
- 64 Performance Geldings, Level 1 Youth
- 65 Yearling Mares, Youth
- 66 Two Year Old Mares, Youth
- 67 Three Year Old Mares, Youth
- 68 Aged Mares, Youth
- 69 Youth Performance Halter Mare
- Grand & Reserve Youth Mares
- 72 Yearling Mares, Level 1 Youth
- 73 Two Year Old Mares, Level 1 Youth
- 74 Three Year Old Mares, Level 1 Youth
- 75 Aged Mares, Level 1 Youth
- 76 Performance Mares, Level 1 Youth
- \*77 All Breed Halter Jr Horse 5 and Under
- \*78 All Breed Halter Sr Horse 6 and Over
- 79 Rookie Youth Showmanship
- 80 Level 1 Youth Showmanship
- 81 Youth 13 & Under Showmanship
- 82 Youth 14 thru 18 Showmanship
- 83 Rookie Amateur Showmanship
- 84 Level 1 Select Showmanship
- 85 Level 1 Am Showmanship
- 86 Select Amateur Showmanship
- 87 Amateur Showmanship

- \*88 W/T All Breed 11 & U Showmanship
- \*89 All Breed Showmanship Walk Trot 12-18
- \*90 All Breed Showmanship Walk Trot 19 & O
- \*91 All Breed Showmanship 14 and U
- \*92 All Breed Showmanship 15 and Over
- SUNDAY ONLY-301 Yearling Longeline Futurity**
- \$250 Added Money- \$100 Entry —\$80 Jackpotted**
- 93 English Warm Up Class**
- 94 Level 1 Open Horse HUS
- 95 W/T Level 1 Youth 18 & Under HUS
- 96 Rookie Youth HUS
- 97 Level 1 Youth HUS
- 97 Youth 13 & Under HUS
- 99 Youth 14 - 18 HUS
- 100 Walk Trot Level 1 Amateur HUS
- 101 Rookie Amateur HUS
- 102 Level 1 Amateur HUS
- 103 Amateur HUS**
- 104 Open HUS**
- \*105 Walk Trot ( All Breed) 11 & Un HUS
- \*106 All Breed HUS Walk Trot 12-18
- \*107 All Breed HUS Walk Trot 19 and Over
- \*108 All Breed HUS 14 and Under
- \*109 All Breed HUS 15 and Over
- SUNDAY ONLY 303 All Breed HUS 4 and Under**
- \$250 Added Money- \$100 Entry —\$80 Jackpotted**
- Hunt Seat Equitation**
- \*110 Walk Trot ( All Breed) 11 Under HS Eq
- 111 Rookie Youth 18&U Hunt Seat Eq
- 112 Level 1 Youth Hunt Seat Eq
- 113 Youth 13 & Under Hunt Seat Eq
- 114 Youth 14 thru 18 Hunt Seat Eq
- 115 W/T Level 1 Amateur Hunt Seat Eq
- 116 Rookie Amateur Hunt Seat Eq
- 117 Level 1 Amateur Hunt Seat Eq
- 118 Select Amateur Hunt Seat Eq**
- 119 Amateur Hunt Seat Eq**
- 120 Walk Trot LEVEL 1 Youth Hunt Seat Eq
- \*121 All Breed HSE Walk Trot 12-18
- \*122 All Breed HSE Walk Trot 19 and Over
- \*123 All Breed Hunt Seat Eq 14 and Under
- \*124 All Breed Hunt Seat Eq 15 and Over

- SUNDAY ONLY**
- 300 All Breed 2 YO Open Futurity \$250**
- Added Money- \$100 Entry —\$80 Jackpotted**
- 302 Sheila McNeil Memorial All Breed Western**
- Plr 2 YO Non Pro \$250 Added Money- \$100**
- Entry —\$80 Jackpotted**
- SATURDAY 8:00AM**

(Schooling Friday after show)

- 125 Level 1 Open Horse Trail
- 126 Junior Trail**
- 127 Rookie Youth Trail
- 128 Rookie Amateur Trail
- 129 Level 1 Youth Trail
- 130 Level 1 Amateur Trail
- 131 Youth 13 & Under Trail
- 132 Youth 14-18
- 133 Select Amateur Trail
- 134 Amateur Trail**
- 135 Senior Trail**
- Pro Am Trail Sweepstakes—open to all breeds -**
- 136- Pro Trail Sweepstakes run**
- 137- Amateur Youth Trail Sweepstakes run**
- Trail Sweepstakes 250.00 Added—50.00 Entry fee per team Buckles to winning team
- \*138 All Breed Trail 14 and Under
- \*139 All Breed Trail 15 and Over
- 140 W/T Level 1 Youth 18 & Under Trail
- 141 Walk Trot Level 1 Amateur Trail
- \*142 Walk Trot All Breed 11 & Under Trail
- \*143 All Breed Walk Trot 12-18 Trail
- \*144 All Breed Walk Trot 19 and Over Trail
- All Breed Futurities —1 go, 2 judges**
- SATURDAY Night Only**
- 304 All Breed Western Plr 3 YO Open \$250**
- Added Money- \$100 Entry —\$80 Jackpotted**
- 305 All Breed Ranch Rail \$500**
- Added Jackpot—\$25 Entry —\$10 Jackpotted**
- 306 Janet Buckner Memorial All Breed Western Pl 3**
- YO Non Pro \$250 Added Money- \$100 Entry —\$80**
- Jackpotted**

- \*145 LEADLINE (All Breed) 8 and Under
- The NW Emerald Masters 2 year old Futurity**
- Sponsor Machine Made**
- Dr Candice Hall and Dr Cory Seebach**
- FRIDAY/MONDAY 8:00AM**

### Western Riding

- 146 Level 1 Open Horse Western Riding
- 147 Rookie Youth Western Riding
- 148 Level 1 Youth Western Riding
- 149 Youth 18 & Under Western Riding
- 150 Junior Horse Western Riding**
- 151 Rookie Amateur Western Riding
- 152 Level 1 Amateur Western Riding
- 153 Select Amateur Western Riding**
- 154 Amateur Western Riding**
- 155 Senior Horse Western Riding**
- \*156 All Breed Western Riding 13 and Under
- \*157 All Breed Western Riding 14-18
- \*158 All Breed Western Riding 19 and Over
- Ranch Riding**
- 159 Rookie Youth Ranch Riding
- 160 Level 1 Youth Ranch Riding
- 161 Youth Ranch Riding
- 162 Rookie Amateur Ranch Riding
- 163 Level 1 Amateur Ranch Riding
- 164 Amateur Ranch Riding**
- 165 Open Ranch Riding**
- \*166 All Breed Ranch Riding 18 and Under
- \*167 All Breed Ranch Riding 19 and Over
- \*168 All Breed Walk Trot 11 and Under
- \*169 All Breed RR Walk Trot 12-18
- \*170 All Breed RR Walk Trot 19 and Over
- Western Pleasure**
- 171 Western Warm Up Class**
- 172 Level 1 Open Western Pleasure
- 173 Walk Jog Level 1 Yth Western Pleasure
- 174 Rookie Youth Western Pleasure
- 175 Level 1 Youth Western Pleasure
- 176 Youth 13 & U Western Pleasure
- 177 Youth 14-18 Western Pleasure
- 178 Junior Horse Western Pleasure**
- 179 Walk Jog Level 1 Am Western Pleasure
- 180 Rookie Amateur Western Pleasure
- 181 Level 1 Select Am Western Plsr
- 182 Level 1 Amateur Western Pleasure
- 183 Select Amateur Western Pleasure**
- 184 Amateur Western Pleasure**
- 185 Sr Horse Western Pleasure**
- \*186 W/J All Breed 11 & U West Pleasure
- \*187 All Breed Western Pleasure WJ 12-18
- \*188 All Breed Western Pleasure WJ 19 and Over
- \*189 All Breed Western Pleasure 14 and Under
- \*190 All Breed Western Pleasure 15 and Over

### FRIDAY ONLY

- All Breed 3 YO Pleasure Versatility Challenge**
- \$250 Added -\$50 Entry—\$30 Jackpotted**

### Horsemanship

- \*191 Walk Jog Level 1 Yth 18&U HMS
- \*192 Wk Jog All Breed 11&U Horsemanship
- 193 Walk Jog Level 1 Am Horsemanship
- 194 Rookie Amateur Horsemanship
- 195 Level 1 Am Select Horsemanship
- 196 Level 1 Amateur Horsemanship
- 197 Select Amateur Horsemanship**
- 198 Amateur Horsemanship**
- 199 Rookie Youth Horsemanship
- 200 Level 1 Youth Horsemanship
- 201 Youth 13 & Under Horsemanship
- 202 Youth 14 thru 18 Horsemanship
- \*203 All Breed Horsemanship WJ 12-18
- \*204 All Breed Horsemanship WJ 19 and Over
- \*205 All Breed Horsemanship 14 and Under
- \*206 All Breed Horsemanship 15 and Over
- \*207 All Breed Walk Trot Bareback
- \*208 All Breed Bareback 14 and Under
- \*209 All Breed Bareback 15 and Over

### Sponsored by Machine Made

**NEW- Circuit buckles to the highest placing Youth or Amateur in the Bold and Underlined Jr/ Sr Classes-Circuit buckle to the highest placing Novice in the Regular Amateur classes**

**MUST SIGN UP PRIOR TO THE SHOW ONLINE OR AT THE OFFICE**

SHOW # 1

# Showmanship at Halter

## Walk Trot

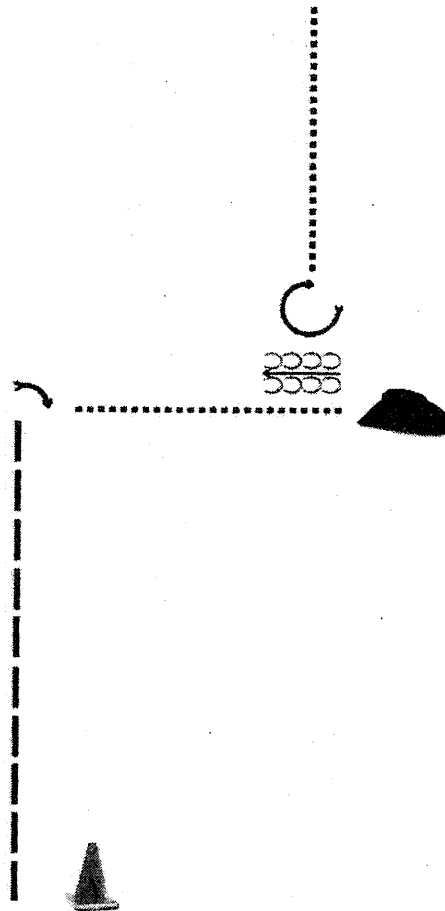

### Instructions

Be ready at the first marker

1. Walk until even with the judge
2. Stop and perform a 90 turn
3. Walk to judge
4. Stop and set up
5. Inspection
6. When dismissed back a horse length
7. Perform a 270 turn
8. Exit at a walk

*Pattern Provided by Andrea Simons*

# Showmanship at Halter

Novice

Level 1 Rookie

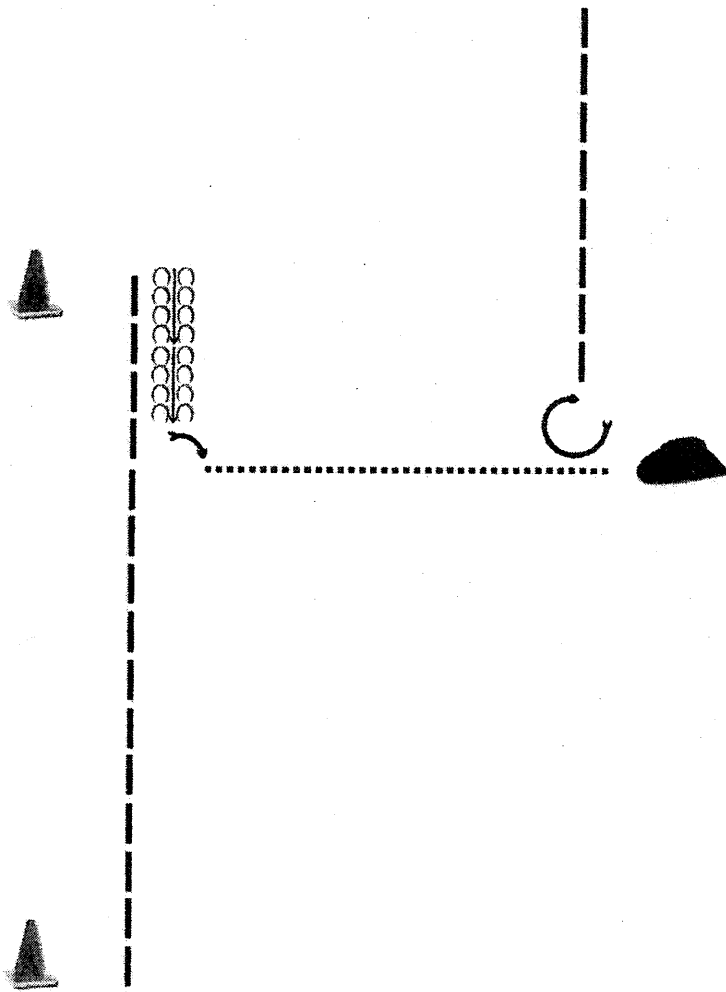

## Instructions

Be ready at the first marker

1. Trot to the second marker
2. Back until even with the judge
3. Perform a 90° and walk to the judge
4. Stop and set up
5. Inspection
6. When dismissed perform a 270° and exit at a trot

*Pattern Provided by Andrea Simons*

# Showmanship at Halter

Youth & Amateur

All Breed  
15+ over  
14+ under

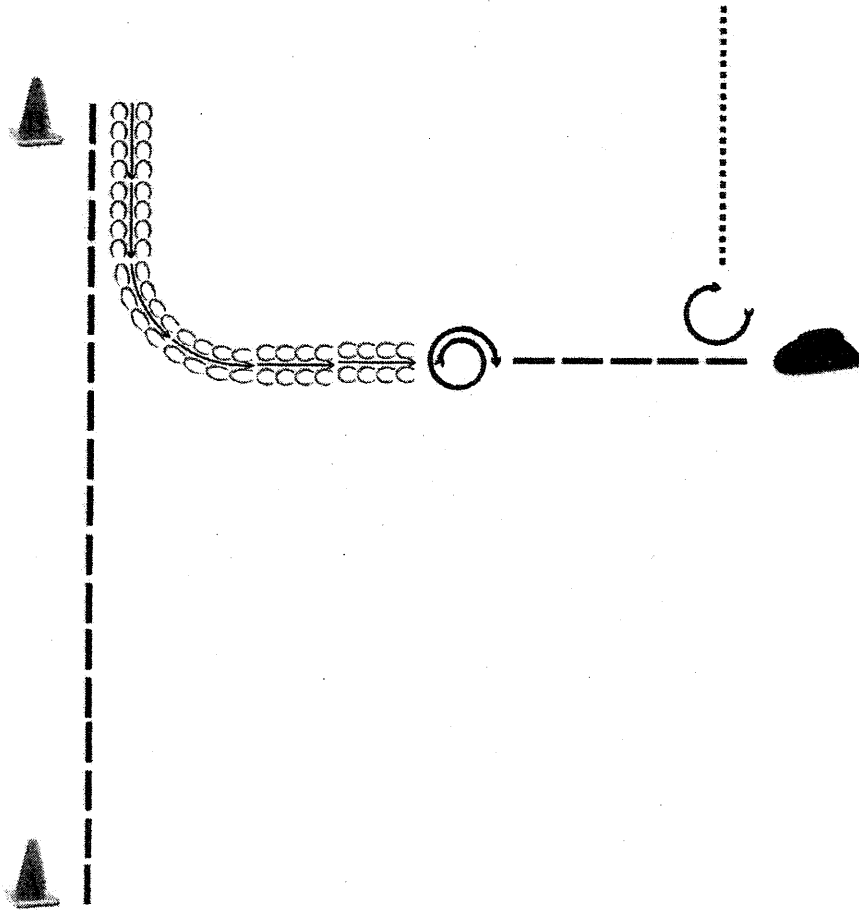

## Instructions

Be ready at the first marker

1. Trot to the second marker
2. Back part way to judge as shown
3. Execute a 540
4. Trot to judge
5. Stop and set up
6. Inspection
7. When dismissed perform a 270 and exit at a walk

*Pattern Provided by Andrea Simons*

# Western Horsemanship

## Walk Trot

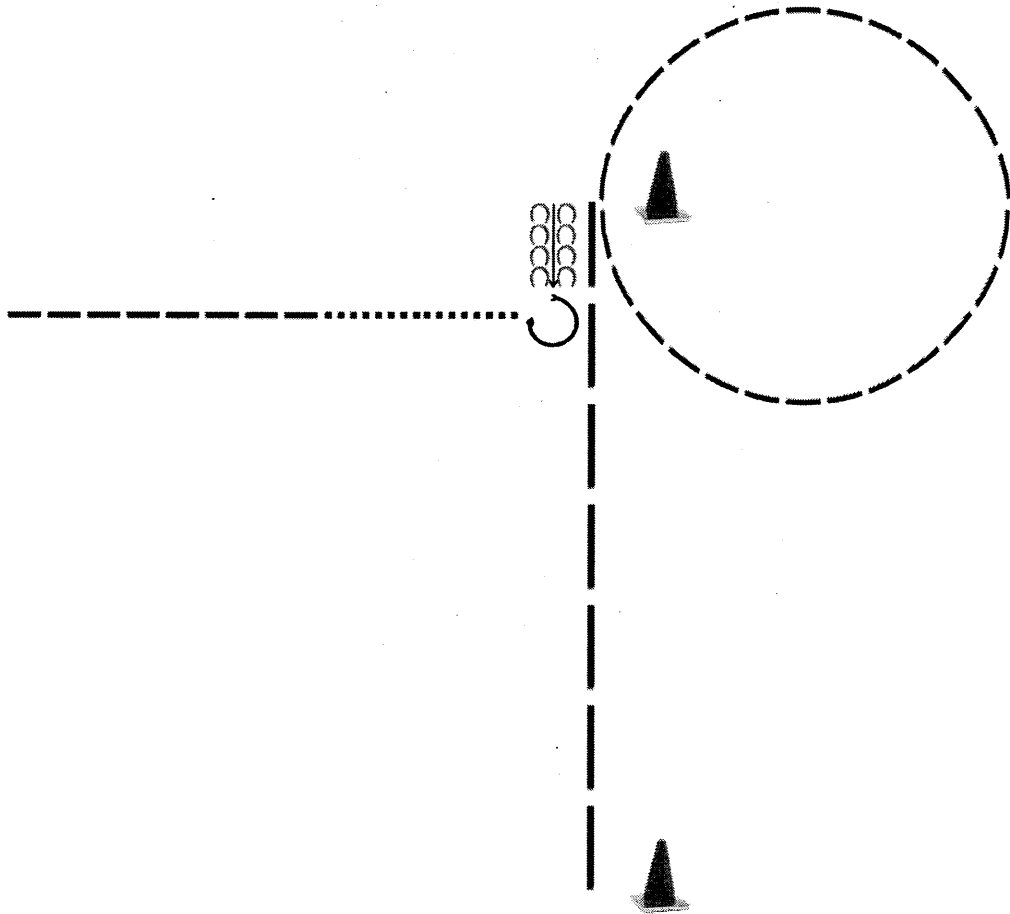

### Instructions

- 1) Extended trot to B
- 2) Jog a circle around B
- 3) Stop and back
- 4) Perform a 270° turn to the right
- 5) Walk
- 6) Exit at the jog

### Legend

Walk	.....
Jog	-----
Extended Trot	—— ———
Lope	—————
Back	⊖⊖⊖⊖ ⊖⊖⊖⊖

# Western Horsemanship

Novice

All Breed 14+ under

Level

Rookie

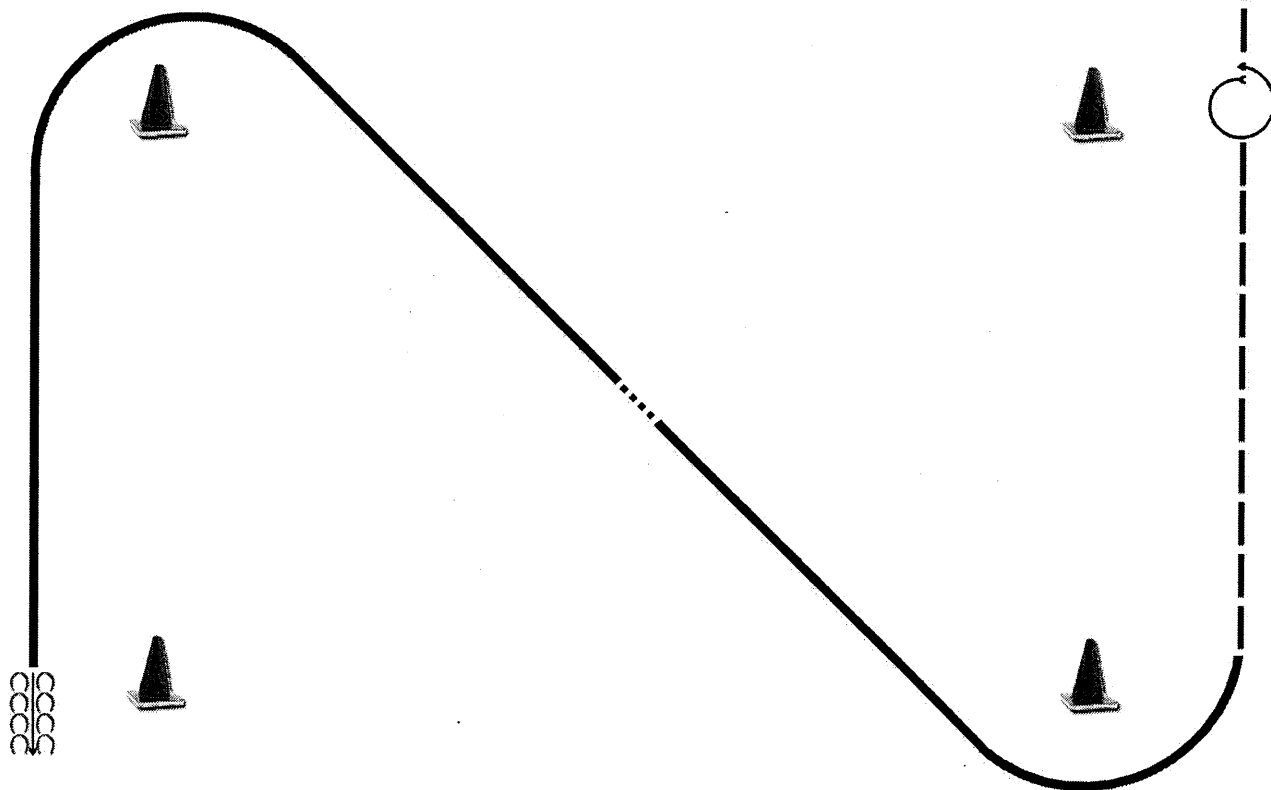

## Instructions

Be Ready at A

- 1) Back one horse length
- 2) Lope right lead around B
- 3) Halfway between B and C walk 1 stride
- 4) Lope left lead around C
- 5) Break to the extended jog and jog to D
- 6) Perform a 360° turn to the left
- 7) Exit at the jog

*Pattern Provided by Andrea Simons*

# Western Horsemanship

## Youth & Amateur

All Breed 15 + over

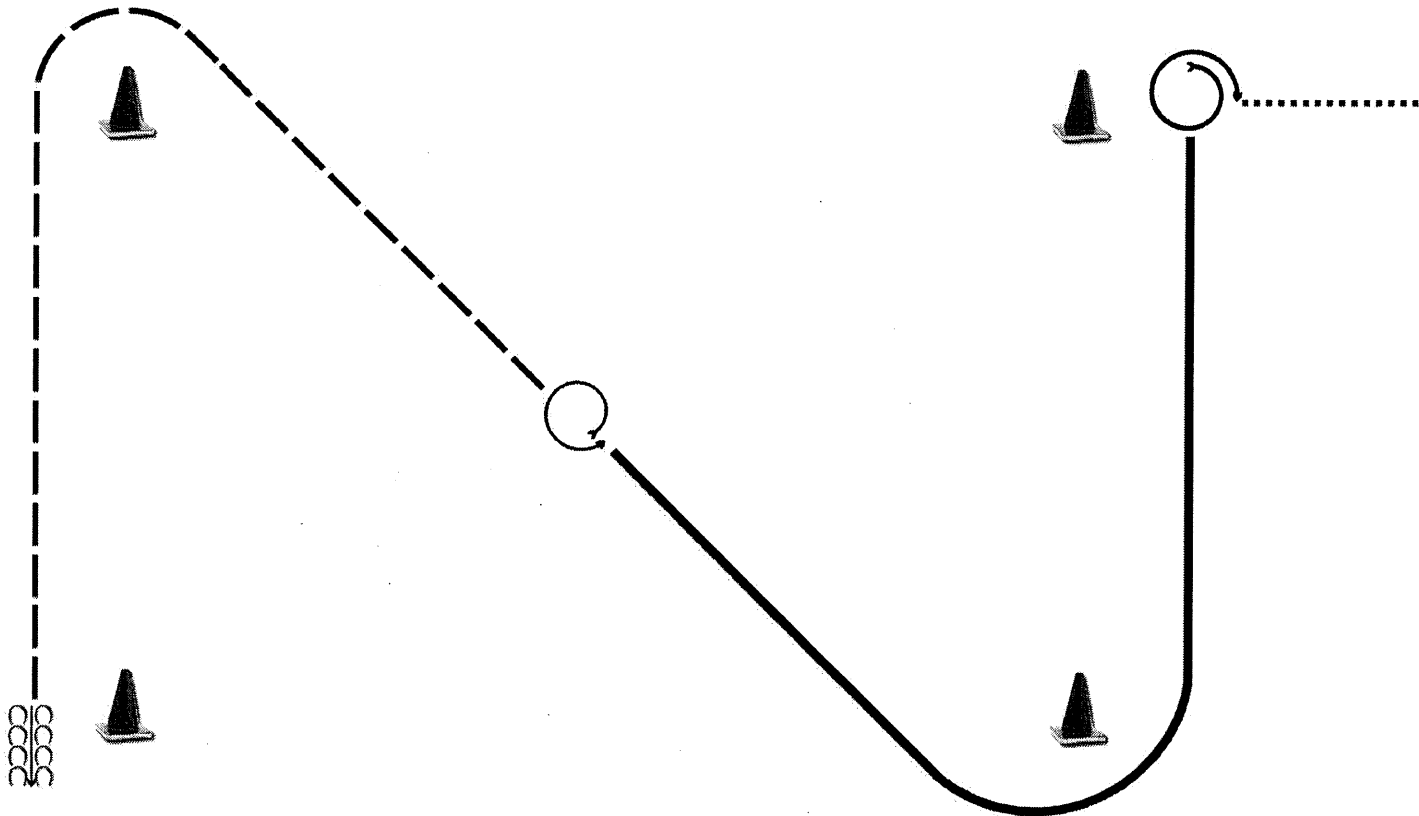

### Instructions

Be Ready at A

- 1) Back one horse length
- 2) Extended jog around B
- 3) Halfway between B and C stop and perform a 360° turn to the left
- 4) Lope left lead around C
- 5) Lope with speed to D
- 6) Stop and perform a 45° turn to the right
- 7) Exit at a walk

*Pattern Provided by Andrea Simons*

# Hunt Seat Equitation

## Walk Trot

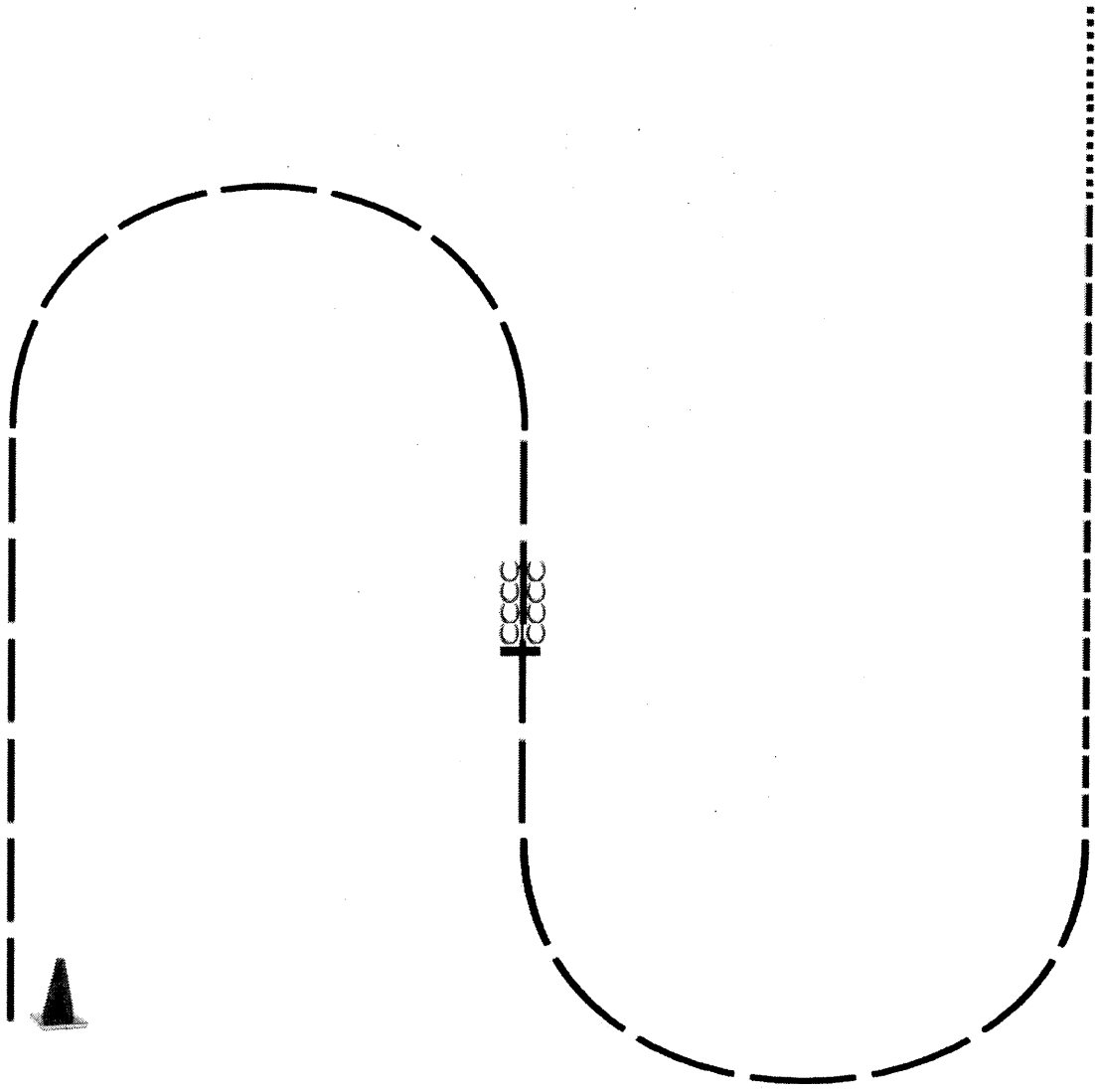

### Instructions

- 1) Trot left diagonal to center
- 2) Stop and back
- 3) Trot right diagonal
- 4) Continue at sitting trot
- 5) Break to walk and exit at walk

### Legend

Walk	.....
Sitting Trot	-----
Trot	-----
Canter	-----
Back	○○○○ ○○○○



# Hunt Seat Equitation

Novice Youth, Novice Amateur

*Rookie Level 1*

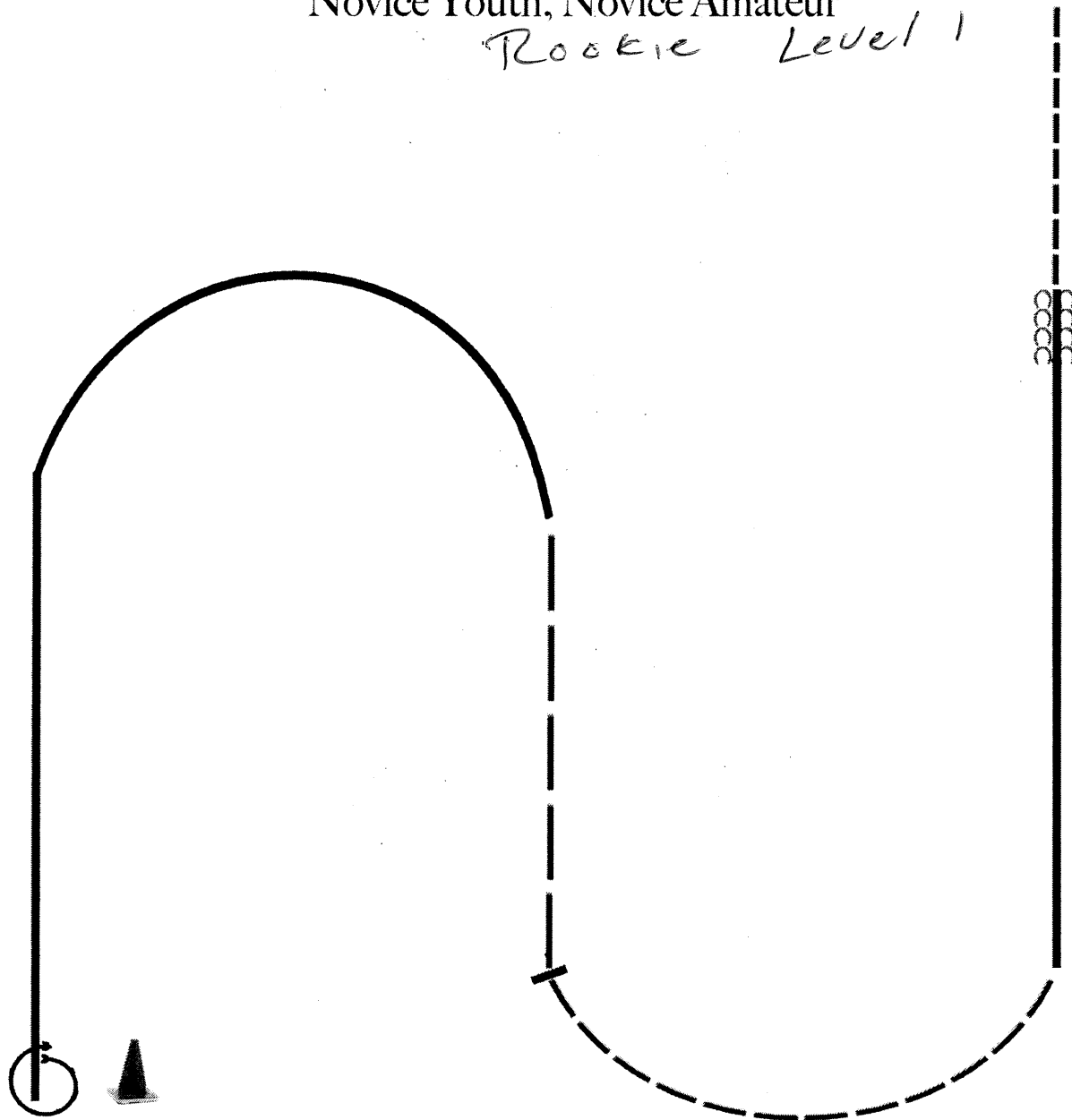

## Instructions

- 1) Perform a 360° turn on the forehand to the left
- 2) Canter right lead as shown
- 3) Break to the trot on the left diagonal
- 4) Continue at the sitting trot
- 5) Canter left lead
- 6) Stop and back
- 7) Exit at the sitting trot

## Legend

Walk	.....
Sitting Trot	-----
Trot	-----
Canter	-----
Back	○○○○ ○○○○

*Simons*

# Hunt Seat Equitation

Youth, Amateur, Select

*All Bred*

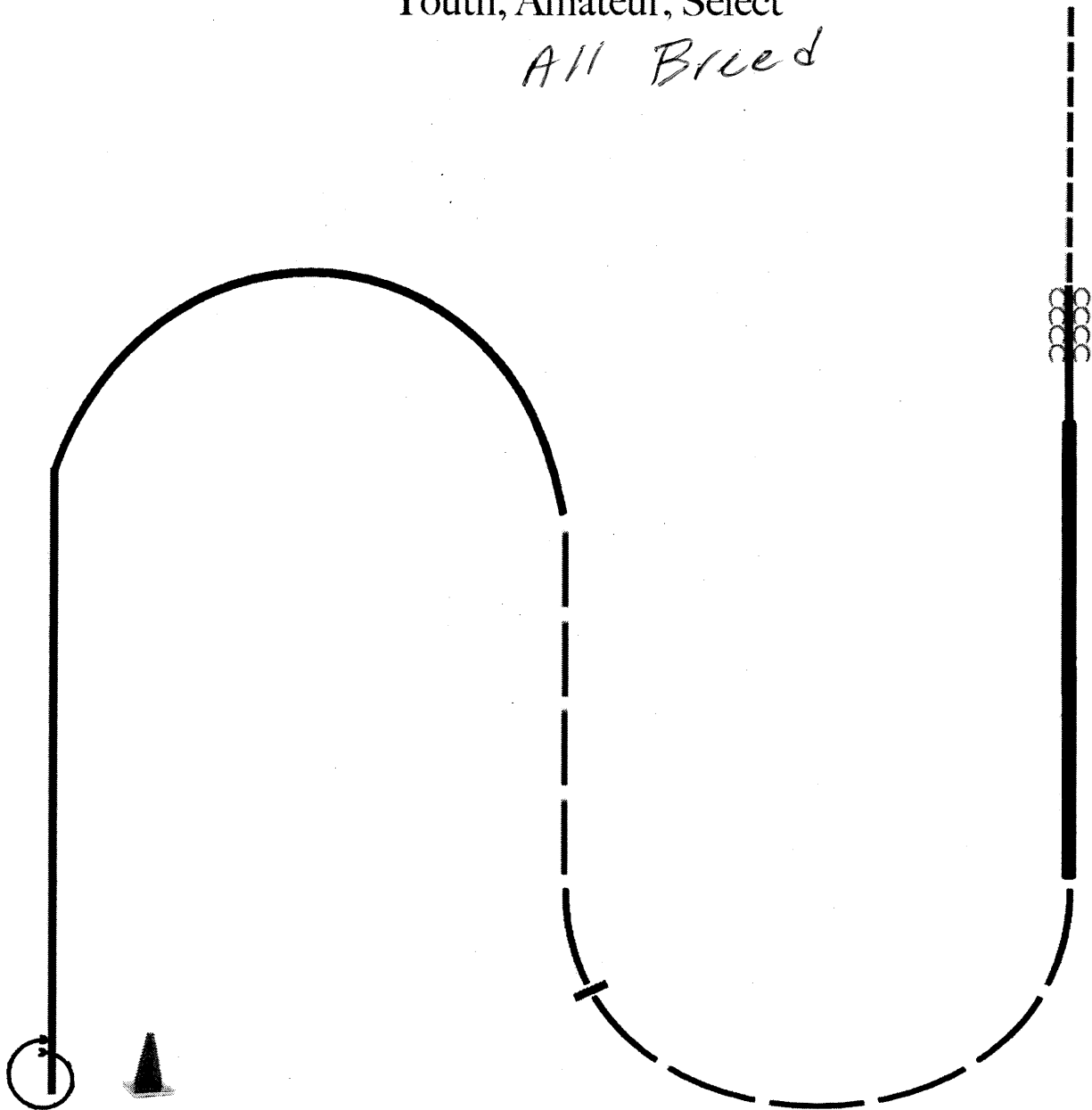

## Instructions

- 1) Perform a 360° turn on the forehand to the right
- 2) Canter left lead as shown
- 3) Break to the trot on the left diagonal
- 4) Continue at the trot in the two-point position where indicated
- 5) Hand gallop on the right lead
- 6) Collect canter, stop and back
- 7) Exit at the sitting trot

## Legend

Walk	.....
Sitting Trot	-----
Trot	-----
Canter	-----
Back	○○○○ ○○○○

*Simons*

**WESTERN RIDING PATTERN 4**

All Breed 14-18  
1970v4

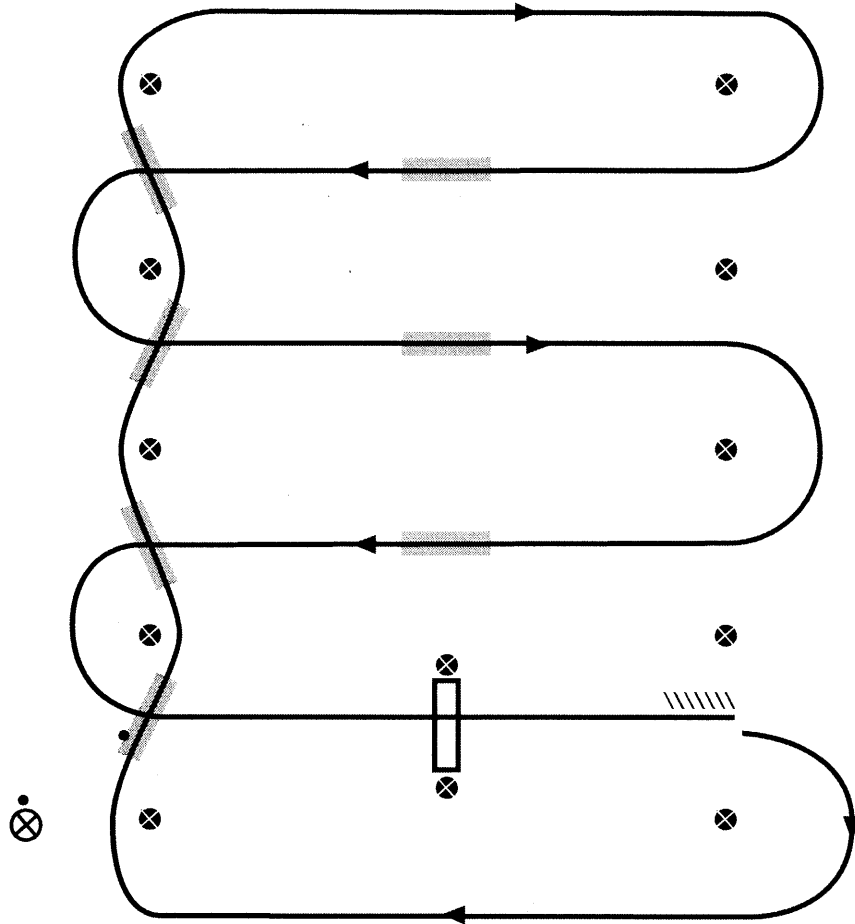

⊗ START CONE      WALK •      • JOG  
LEAD CHANGING AREA [shaded]      LOPE [solid line]

1. Walk at least 15 feet from start cone to the first marker, transition to jog, jog over log.
2. Transition to the lope, on the right lead
3. First line change
4. Second line change
5. Third line change
6. Fourth line change
7. First crossing change
8. Second crossing change
9. Third crossing change
10. Lope over log
11. Lope, stop & back

# LEVEL I WESTERN RIDING PATTERN 4

Rookie

All Breed 13+ under

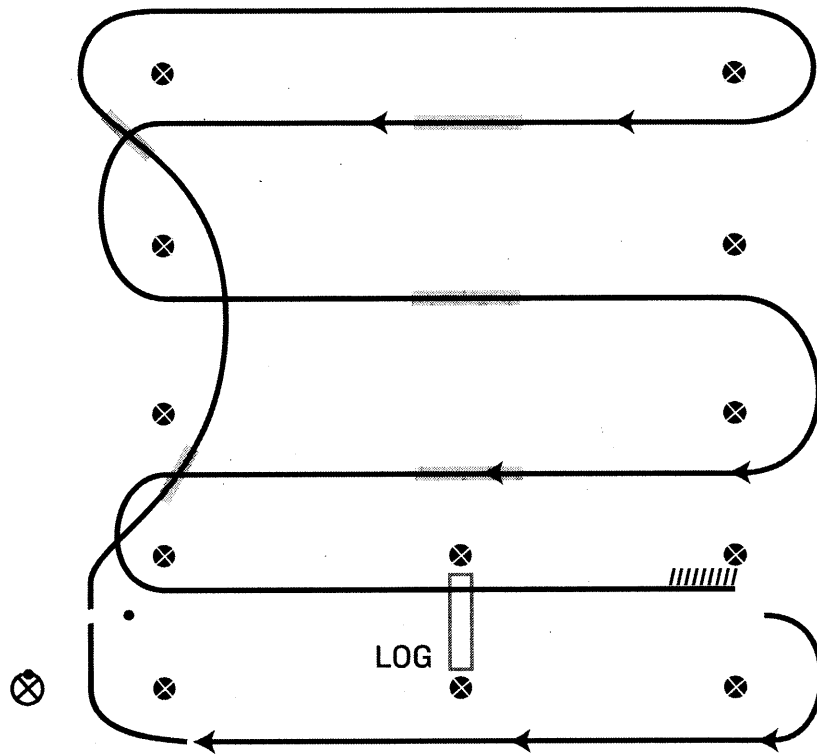

⊗ START CONE      WALK •      • JOG  
LEAD CHANGING AREA [shaded]      [hatched] LOPE [solid line]

1. Walk at least 15 feet from start cone to the first marker, transition to jog, jog over log.
2. Transition to right lead & lope around end
3. First line change
4. Second line change, lope around end of arena
5. First crossing change
6. Second crossing change
7. Third crossing change
8. Lope over log
9. Lope, stop & back

# RANCH RIDING - PATTERN 2 WALK/JOG

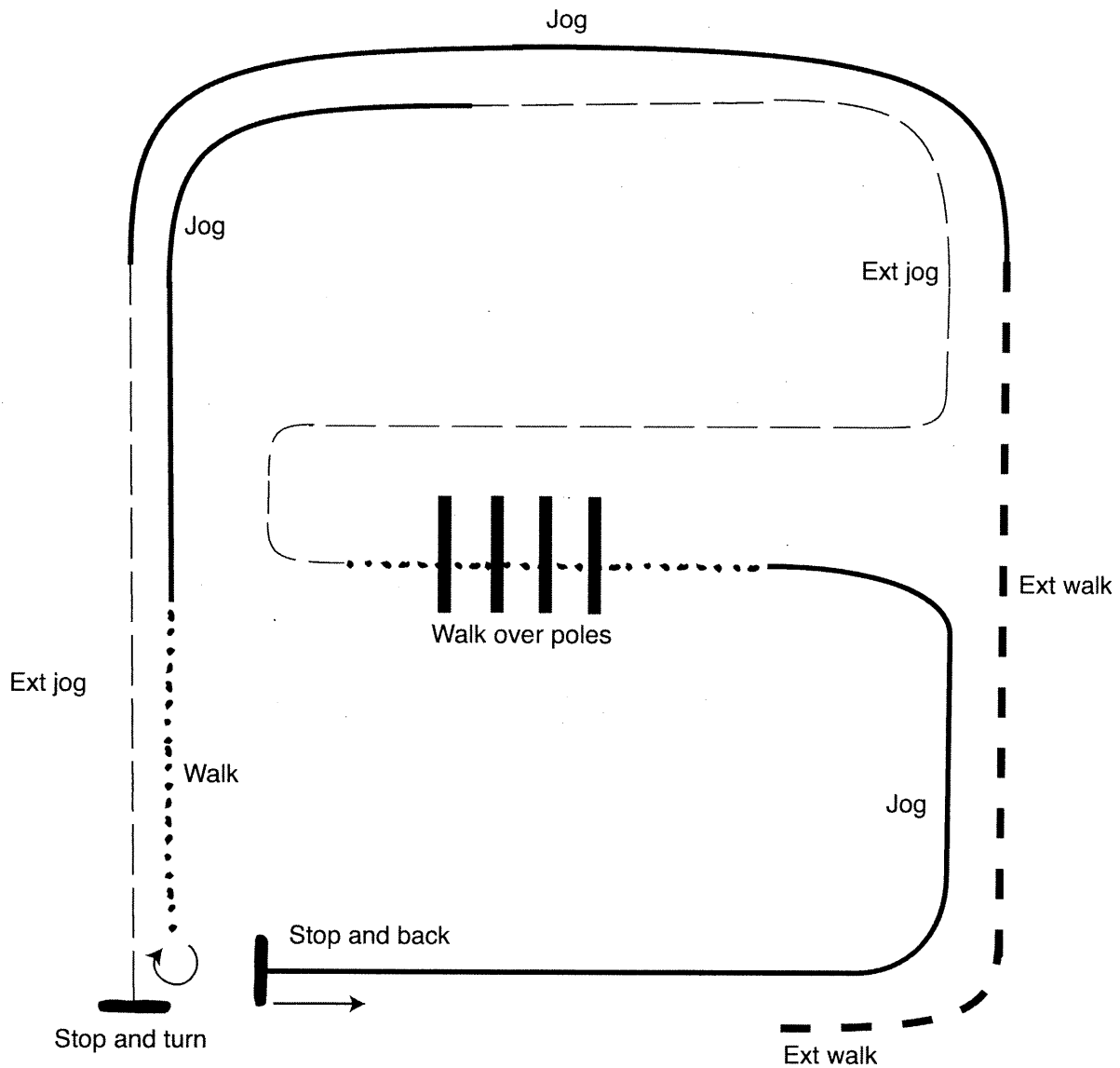

- ..... Walk
- — Extended Walk
- Jog
- — Extended Jog
- Back
- ↻ Turn

26" - 30" spacing between poles/logs

1. Extended walk corner and line
2. Jog
3. Extended jog line
4. Stop and 180 degree turn either direction
5. Walk 1/2 the line
6. Jog 1/2 the line and corner
7. Extend jog around corners
8. Walk over poles
9. Jog corners
10. Stop and back

# September Trophy Circuit

Ranch Riding

All Breed  
Rookie  
Level 1

Show Date:

JR Horse

w w w . H o r s e S h o w P a t t e r n s . c o m

w w w . H o r s e S h o w P a t t e r n s . c o m

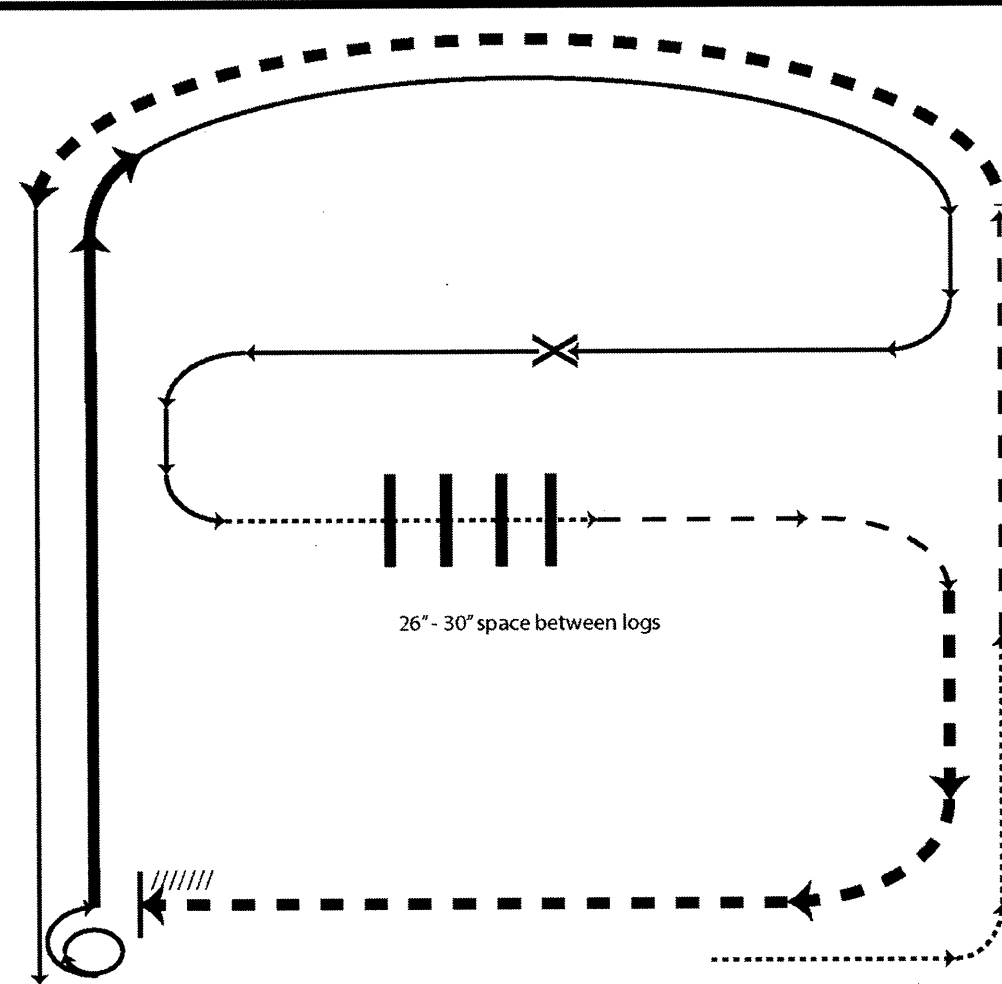

26" - 30" space between logs

- X Lead Change
- • Walk
- - Trot
- - - Ext Trot
- ==== Lope
- ===== Ext Lope
- /////// Back

1. Walk
2. Trot
3. Extended trot
4. Left lead lope
5. Stop, 1 1/2 turn right
6. Extended lope
7. Collect to working lope-right lead
8. Change leads (simple or flying)
9. Walk
10. Walk over logs
11. Trot
12. Extended trot
13. Stop and back

[RR/AQHA-2]

Pattern Provided by:

# September Trophy Circuit

Ranch Riding

Show Date:

YOUTH  
SELECT / Am  
SR HORSE

www.HorseShowPatterns.com

www.HorseShowPatterns.com

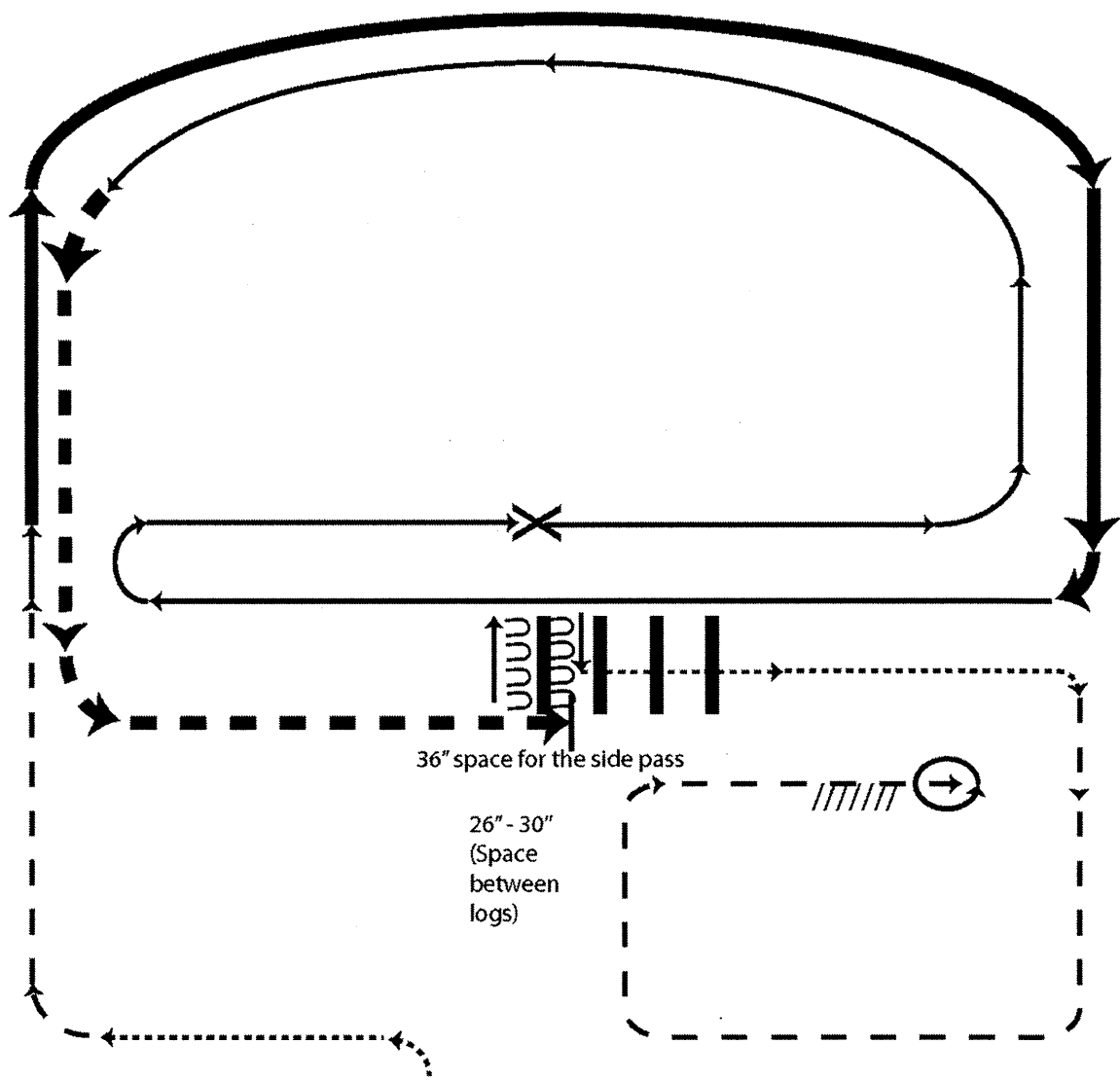

1. Walk
2. Trot
3. Extended lope-right lead
4. Lope-right lead
5. Change leads(simple or flying)
6. Lope left lead
7. Extended trot
8. Stop, side pass left, side pass right, 1/2 way
9. Walk over logs
10. Walk
11. Trot square
12. Stop, 360° turn left, back

- X Lead Change
- Walk
- - - Trot
- - - Ext Trot
- — — Lope
- — — Ext Lope
- /////// Back

[RR/AQHA-4]

Pattern Provided by:

# September Trophy Circuit

Barback Western Horsemanship *WALK TROT*

Show Date:

www.HorseShowPatterns.com

www.HorseShowPatterns.com

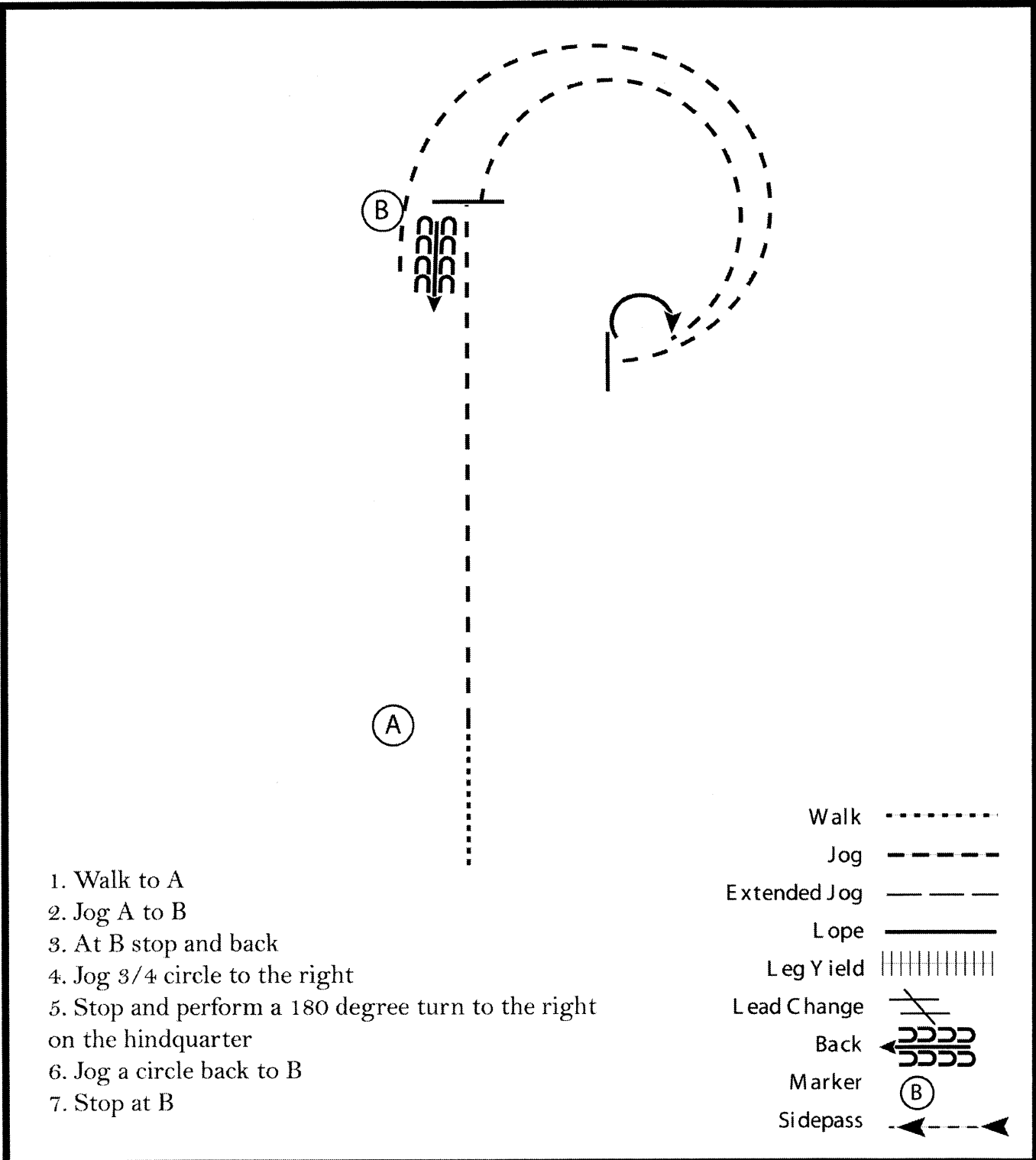

1. Walk to A
2. Jog A to B
3. At B stop and back
4. Jog 3/4 circle to the right
5. Stop and perform a 180 degree turn to the right on the hindquarter
6. Jog a circle back to B
7. Stop at B

- Walk ..... (dotted line)
- Jog - - - - - (dashed line)
- Extended Jog - - - - - (long dashed line)
- Lope \_\_\_\_\_ (solid line)
- Leg Yield ||||| (vertical bars)
- Lead Change / (diagonal slash)
- Back ←←← (backward arrows)
- Marker (B) (circle with B)
- Sidepass ←← (dashed line with arrows)

[WH/WT-12]

Pattern Provided by:



# September Trophy Circuit

Bareback Western Horsemanship 14 + under

Show Date:

www.HorseShowPatterns.com

www.HorseShowPatterns.com

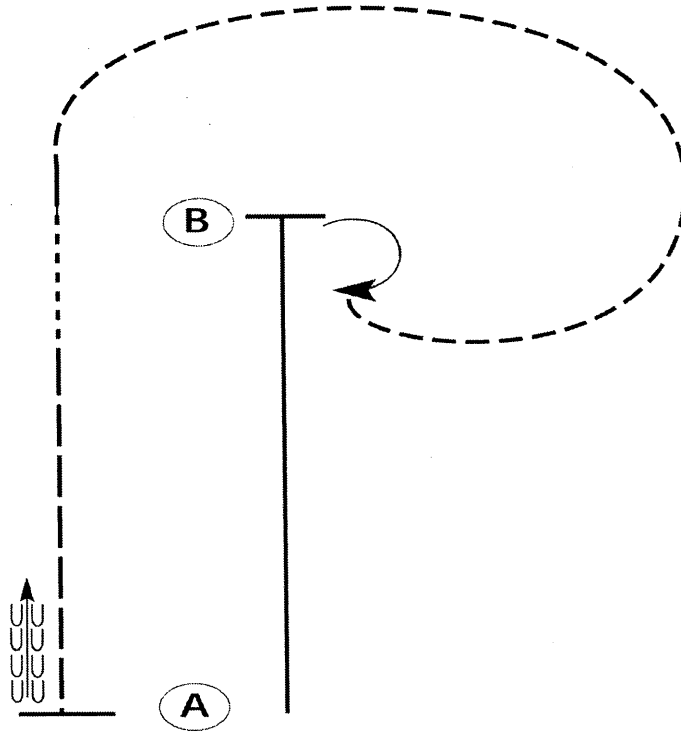

Be ready at A.

1. Lope on the right lead to B.
2. Turn 180 degrees to the right.
3. Jog back around to B.
4. At B, break to the walk.
5. Walk approximately 10 feet.
6. Extend the jog to A.
7. Stop at A and back approximately one horse length.

Follow the instructions of your ring steward.

Walk	-----
Jog	- - - - -
Extended Jog	-----
Lope	—————
Leg Yield	
Lead Change	— / —
Back	← ⊂ ⊂ ⊂ ⊂ ⊂
Marker	⊙ B
Sidepass	← - - - - - ←

[WH/1-43]

Pattern Provided by:

# September Trophy Circuit

Baraback Western Horsemanship IS+over

Show Date:

w w w . H o r s e S h o w P a t t e r n s . c o m

w w w . H o r s e S h o w P a t t e r n s . c o m

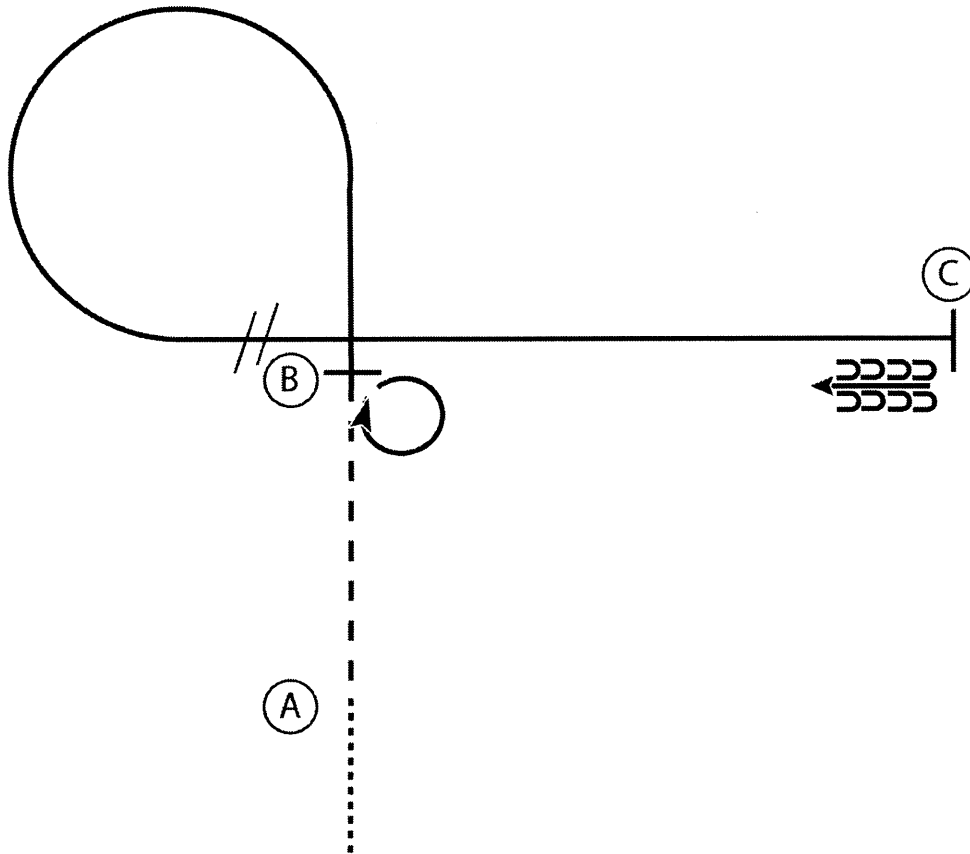

1. Walk to A
2. At A jog to B
3. Stop at B and perform a 360 degree turn to the right
4. Lope a circle to the left
5. At B perform a lead change and continue to C
6. At C stop and back 5 steps

Walk	.....
Jog	-----
Extended Jog	-----
Lope	—————
Leg Yield	
Lead Change	↙↘
Back	←←←←←
Marker	⊙ B
Sidepass	←←←←←

[WH/2-10]

Pattern Provided by: